

Operating Manual

Series 580 TCD Isothermal Gas Chromatograph

Series 580: 120 V, 50/60 Hz

Series 582: 230 V, 50/60 Hz

September 2017

Rev. 5

**READ INSTRUCTIONS
BEFORE OPERATING**



277 Brodhead Rd., Bethlehem, PA 18017-8600 U.S.A. Tel: (610) 954-9000

DISCLAIMERS

The information in this document is subject to change without notice. This manual could include technical inaccuracies or typographical errors. Changes are made periodically to the information herein; these changes will be incorporated in subsequent revisions of the manual. GOW-MAC® Instrument Co. reserves the right to make improvements and/or changes to the product(s) and/or programs described in this manual at any time and without notice.

All information referred to and/or included in this report is current as of the original issue date of this manual. GOW-MAC® Instrument Co. makes no warranty or representation with respect to the accuracy of the information or with respect to the suitability of the use of such information outside GOW-MAC® Instrument Co., nor does GOW-MAC® Instrument Co. assume responsibility for any injury or damage which may result, directly or indirectly, from the use of such information.

This document contains proprietary information which is protected by copyright. All rights are reserved. No part of the document may be photographed, reproduced, or translated into another language without the prior written consent of GOW-MAC® Instrument Co.

The warranties made by GOW-MAC® Instrument Co. with respect to the product are voided if the product is not used and serviced in accordance with the instructions in this manual.

Please protect yourself and your employees by following these operating instructions. We encourage our customers to write or call for any additional information relative to the use or repair of this instrument.

TRADEMARK AND PATENT INFORMATION

®GOW-MAC is a registered trademark of GOW-MAC Instrument Co.
in the United States and other countries. (Reg. U.S. Pat. & T. M. office)

Other trademarks used herein are trademarks or registered trademarks of their respective owners.

TERMS AND CONDITIONS OF SALE

WARRANTIES THE INSTRUMENTS SOLD BY GOW-MAC® INSTRUMENT CO. ARE WARRANTED FOR A PERIOD OF ONE YEAR AGAINST DEFECTS IN MATERIALS AND WORKMANSHIP. THE TERMS OF THIS WARRANTY ARE AS FOLLOWS:

1. The warranty period begins with the shipping date of the equipment to the original purchaser.
2. Certain parts such as batteries, fuses, lamps, filaments, columns, etc., are expendable in normal use, and their service life is unpredictable. Such items are not covered by this warranty.
3. All requests for service or repair under this warranty must be received within the warranty period by GOW-MAC® or its authorized representative. All repairs are made at GOW-MAC plants or at the office of authorized representatives.
4. All repairs, adjustments, and other service under this warranty shall be performed free of charge to the purchaser. However, warranty service and repairs shall be limited to equipment malfunctions which, in the opinion of GOW-MAC®, are due or traceable to defects in original materials or workmanship. Instrument malfunctions caused by abuse or neglect of the equipment are expressly not covered by this warranty.
5. Instrument parts which have been repaired or replaced during the warranty period are themselves warranted only for the remaining unexpired portion of the original one year warranty.
6. Repairs, adjustments, and service performed after expiration of the one year warranty period shall be charged to the purchaser at the then current prices for parts, labor, and transportation.
7. This warranty attaches to the equipment itself and is not limited to the original purchaser. Unexpired portions of the warranty are thus transferable to subsequent owners.
8. GOW-MAC® expressly disclaims any liability to users of its products for consequential damages of any kind arising out of or connected with the use of its products.
9. Except as stated in Sections 1 through 8 above, GOW-MAC® makes no warranty, expressed or implied (either in fact or by operation of law), statutory or otherwise; and, except as stated in Sections 1 through 8 above, GOW-MAC® shall have no liability under any warranty, expressed or implied (either in fact or by operation of law), statutory or otherwise.
10. Statements made by any person, including representatives of GOW-MAC® which are inconsistent or in conflict with the terms of this warranty shall not be binding upon GOW-MAC® unless reduced to writing and approved by an officer of the Company.
11. This warranty shall be governed by the laws of the Commonwealth of Pennsylvania.

LIABILITY Buyer assumes all responsibility for warning and protecting its employees and independent contractors with respect to all hazards to persons and property in any way connected with the Equipment and the use thereof. Seller's liability for any claim of any kind hereunder, whether or not based on contract, tort (including negligence), strict liability, warranty, or any other grounds, shall not exceed the purchase price of the Equipment or the portion of the purchase price attributable to any part or parts of the Equipment in respect to which such claim is made. Seller shall not be liable for any special, indirect, incidental, or consequential damages. Without limiting the generality of the foregoing, Seller shall have no liability with respect to the results obtained by use of the Equipment, whether in terms of product condition, operating cost, general effectiveness, success or failure, or regardless of any statement made in any written proposal submitted by Seller. It is expressly understood that any technical advice furnished by Seller with reference to the Equipment is given gratis and Seller assumes no obligation or liability for the advice given or results obtained, all such advice being given and accepted at Buyer's risk. Each party hereby agrees to indemnify and hold the other party harmless from any actions, lawsuits, demands, claims, losses, expenses, costs, including but not limited to legal fees, and damages arising from the injury, illness or death of the indemnifying party's employees in any way related to the Equipment, whether or not such injury, illness, or death is claimed to have been caused by, resulted from, or was in any way connected with the negligence of the party to be indemnified.

PROPRIETARY INFORMATION Buyer agrees to maintain all proprietary information disclosed by Seller, including such proprietary information obtainable upon examination of the Equipment, in confidence and to refrain from any disclosure thereof to any third party (including any affiliate of Buyer), for any purpose, without the prior written consent of Seller. Buyer agrees to use said proprietary information solely for purposes of maintaining and operating the Equipment, and to refrain from any use thereof to design, construct, have constructed and/or operate any duplication or modification of the Equipment, or from any other use thereof, without the prior written consent of Seller.

IMPORTANT INFORMATION

These instructions are written for personnel operating the GOW-MAC® Series 580 TCD Gas Chromatograph. Read and understand the safety precautions in this manual to become familiar with the safe practices for operating this equipment.

Dangers, Warnings, Cautions, and Notes

Dangers, Warnings, Cautions, and Notes appear throughout this manual. A sample of each statement appears below. Within each sample, a definition of the statement type and its purpose is given.



DANGERS alert you to an immediate hazard that causes serious injury or death and requires special precautions to be taken.



WARNINGS alert you to a potential hazard that causes serious injury or death *under certain conditions*.



CAUTIONS alert you to a non-immediate or potential hazard or an unsafe practice that presents a minor threat of personal injury or damage to equipment, data, or processes.



NOTES emphasize or remind you of an important piece of information.

Contents

Section 1	Specifications	13
Section 2	Safety.....	15
Section 3	Installation.....	17
Section 4	Operating Controls.....	25
Section 5	Operation.....	29
Section 6	Valves	37
Section 7	Maintenance.....	43
Section 8	Options & Accessories	51
Section 9	Troubleshooting	55
Section 10	Replacement Parts	63
Section 11	Drawings & Schematics.....	65

Series 580 Thermal Conductivity Isothermal Gas Chromatograph Operation & Maintenance Manual

This manual provides operating instructions and maintenance requirements for the Series 580 GC to permit safe and efficient use of your instrument. Throughout this manual, special “NOTE”, “CAUTION”, and “WARNING” signs appear for your protection. It is important that you thoroughly read the appropriate sections of this manual before operating your instrument. Certain sections of this manual apply to specific options you may have chosen for your instrument. The information contained within concerns itself with a standard hotwire detector GC. If you have Options 204 or 218 (Capillary) installed, make sure to read Section 8. Operate the Series 580 GC according to these instructions. Any questions concerning the safe and proper use of your instrument should be addressed to:

**GOW-MAC INSTRUMENT CO.
277 Brodhead Road,
Bethlehem, PA 18017-8600
TEL: (610) 954-9000
FAX: (610) 954-0599
E-mail: sales@gow-mac.com**

IMPORTANT!

Your new Series 580 TCD Isothermal Gas Chromatograph contains one of the following detector/filament configurations:

_____ Single Carrier TCD _____ Dual Carrier TCD

with _____ WX (rhenium-tungsten)
_____ WXB (rhenium-tungsten, inverted header – dual carrier TCD only)
_____ W2B (tungsten, inverted header – dual carrier TCD only)
_____ W2X (rhenium-tungsten, dual helix)
_____ AuW (gold sheathed tungsten)
_____ Ni (nickel)
_____ WX7 (low current, high sensitivity rhenium-tungsten)

FOLLOW THE PRESCRIBED BRIDGE CURRENTS AND CELL TEMPERATURES FOR YOUR PARTICULAR DETECTOR AND SET OF FILAMENTS (REFER TO CHARTS 5-1 thru 5-5 IN THIS MANUAL). FAILURE TO REMAIN WITHIN THE STATED LIMITS WILL CAUSE FILAMENT BURN OUT.

RECOMMENDED STARTING BRIDGE SETTINGS FOR HELIUM

WX	filaments	100 mA
AuW	filaments	100 mA
Ni	filaments	100 mA
WX7	filaments	80 mA

FILAMENT OPERATING NOTES

1. Filament life may be extended by operating at low current and low cell temperatures. The cell temperature should only be as high as needed for samples used, and current should be as low as possible consistent with sensitivity required. It is better to operate the system at an attenuation of 1x or 2x at low bridge currents than at higher currents with higher attenuation.
2. Sensitivity increases 4 to 8 times as filament current increases by a factor of 2. However, increasing filament current excessively results in baseline instability and possible filament burnout. Care must be observed in arbitrarily changing bridge current.

If your instrument was engineered to analyze **corrosive** samples (usually designated by a “-CR” in the part number), take note:



CAUTION!

This instrument was designed for **DRY sample applications only!**

Care must be taken to make sure only moisture-free samples are introduced into the system.

GOW-MAC[®] Instrument Company is not responsible for damage to equipment caused by exposure to hydrolyzed samples.

Section 1 Specifications

(dependent upon the number of options ordered)

OVERALL:

H 12 1/2" (317 mm)
W 19 1/2" (495 mm) width varies due to housing used for options ordered
D 18" (457 mm)

Net Weight: 70 lbs. (31.75 kg) Shipping: 80 lbs. (36.21 kg)

POWER REQUIREMENTS:

Series 580: 105 - 125 Vac, 50/60 Hz, 1100 W

Series 582: 200 - 240 Vac, 50 Hz, 1100 W

Fuse: Series 580: 10 Amps

Series 582: 5 Amps

COLUMN OVEN:

H 7 1/2" (190 mm)

W 10" (254 mm)

D 8 1/2" (216 mm)

Temperature Range: ambient to 400 °C

Temperature Readout: 3 1/2 digit LED digital meter Temperature Control: solid state, time proportioning, RTD sensors, direct reading, ambient to 400 °C

Column Oven Temperature Protection Circuit: shuts the column oven off if the temperature rises to 30 °C over the set point. Oven Fittings: accommodates 1/8" or 1/4" o.d. metal, 6 mm glass, or capillary columns.

Oven Capacity: can accommodate up to two (2) 1/4" o.d. x 20' columns or correspondingly longer lengths of 1/8" o.d.

DETECTOR OVEN:

Temperature Settings: ambient to 400 °C

Temperature Readout: 3 1/2 digit LED digital meter

Temperature Control: solid state time proportioning, RTD sensors, direct reading, ambient to 400 °C

DETECTOR:

Detector Type: thermal conductivity
Design: flow-through
Detector Elements: four (4) Rhenium-tungsten (WX), gold-sheathed tungsten (AuW); nickel (Ni); or high sensitivity rheniumtungsten (WX7) on standard 9225 mount; tube nut closure.
Response Time: 0.5 sec.
Noise: 10 μ V max. within operating parameters
Drift: 40 μ V/hour max.
Carrier Gas: N₂, He, H₂, or Argon
Current Limit: 300 mA with H₂ [Reference recommended starting settings,
120 mA with N₂ Section 5, 2B.b, pgs. 29-32]

INJECTION PORTS:

Septum: standard 9 mm
Temperature Control: solid state, time proportioning, RTD sensors, direct reading, ambient to 400 °C.
Temperature Readout: 0 - 400 °C, 3 1/2 digit LED digital meter
Injection Method: direct on-column or gas sample valves

GAS FLOW (conditions may vary depending upon the options chosen for your instrument)

Dual-column with dual injection ports and exits.
Two metering valves for separate control of each column.
Exit ports allow easy collection of effluent.
Filament protector pressure switch in carrier inlet line.

THERMAL CONDUCTIVITY BRIDGE CONTROL

Continuous current adjust, 0 - 300 mA
Bridge zero adjust
Attenuator for bridge output, 12 positions to 1024 plus infinity (∞)
Polarity Switch

POWER SUPPLY

Line operated, solid state, integrated circuit regulated, constant current
55 Vdc (max.), 300 mA (max.)
Ripple and noise less than 5 μ V

x10 SIGNAL AMPLIFIER (OPTIONAL): amplifies the detector signal by a factor of 10 for enhanced sensitivity.

Section 2

Safety

This section is designed to bring special attention to specific areas or practices that may pose particular hazards to personnel and/or equipment safety only. For complete installation instructions, see Section 3.

It is in the operator's best interest to read this section to ensure the safe operation of the equipment.

A. BURN HAZARDS

The injection ports, columns, and column oven cover may reach very high temperatures, and remain hot for several hours after the instrument has been shutdown. To prevent painful burns resulting from contact with the hot surfaces, wear protective gloves.

B. ELECTRICAL HAZARDS

1. DISCONNECT the instrument from all power sources before removing front, side, and back panels and exposing potentially dangerous voltages.
2. Make sure that the actual line voltage is the value for which the instrument was designed. (for properly grounded outlet ONLY.)
3. DO NOT overload the ac outlet with other electrical equipment.
4. Adhere to the color coding descriptions when hooking up electrical connections.
5. Repair or replace faulty or frayed wiring.

C. COMPRESSED GAS CYLINDERS

Compressed gas cylinders are potential sources of serious accidents, injuries, and even death if proper precautions and safety practices are not followed. Therefore, during handling and use of these gases, be certain to use applicable safety precautions described by your compressed gas supplier, the Compressed Gas Association, and/or O.S.H.A. regulations.

1. Read the label on all cylinders **BEFORE** using to identify the cylinder contents. If the label is illegible, return the cylinder to the supplier. **DO NOT ASSUME THE CONTENTS.**
2. All gas cylinders in use and in storage **MUST** be properly secured to an immovable structure to prevent accidental falling or movement. Read all relevant safety codes.
3. Store or move cylinders **ONLY** in the vertical position.
4. DO NOT move or transport cylinders with regulators attached or without safety cap secured over the valve system.
5. Store cylinders in a well ventilated area away from heat or ignition sources.

6. When installing tubing, provide ONLY proper pressure reducing regulators and pressure relief devices to prevent overpressure of tubing and equipment.

D. GENERAL

1. Perform periodic leak checks on all fittings.
2. Store organic solvents away from the GC in fireproof, vented, labelled cabinets.
3. DO NOT allow flammable and/or toxic wastes to accumulate.
4. Keep combustibles away from gas cylinders and eliminate ignition sources.
5. DO NOT place papers, charts, samples, etc. on top of the GC.
6. Maintain adequate ventilation.
7. Dispose of wastes properly.

Section 3

Installation

A. General

The customer should read and become familiar with this section before proceeding with the installation of the Series 580 GC.

B. Additional Equipment Required

1. Carrier Gas Cylinder: cylinder should be equipped with a two-stage quality regulator for control of the carrier gas. The first gauge indicates the tank pressure and the second (adjustable) gauge indicates the delivery pressure to the chromatograph, (0-75 psig).
2. Potentiometric recorder with 1 mV span, 1 sec. response, or 10 mV span. mV INPUT MUST NOT BE GROUNDED. A computing integrator or chromatography software may also be used.
3. Stopwatch and a 10 mL soap bubble flowmeter for gas flow measurements. A “rotameter” or digital flowmeter may be used for direct reading if it is properly calibrated.
4. AC power source: Series 580: 1100 W at 115 V, 60 Hz
 Series 582: 550 W at 230 V, 50 Hz



OPERATING INSTRUCTIONS FOR BOTH MODELS ARE THE SAME, EXCEPT FOR LINE VOLTAGE REQUIREMENTS. TO PREVENT DAMAGE TO THE INSTRUMENT, MAKE SURE THAT THE AC ELECTRICAL OUTLET IS THE CORRECT VOLTAGE FOR YOUR INSTRUMENT BEFORE PLUGGING IT INTO THE OUTLET.

5. GOW-MAC Installation Kit (Part no. 59-400) or 1/8" o.d. copper tubing and Swagelok® fittings.
6. Columns suitable to your application.

C. Unpacking-Inspection

1. When unpacking the instrument, check it carefully for evidence of shipping damage or rough handling. Check to ensure that all components ordered have either been supplied or back-ordered. Notify the Company of any discrepancies. The packing box should be retained for use if the instrument needs to be returned to the factory for repair or modification. GOW-MAC does not supply field service. ALL repairs are made at Bethlehem, Pennsylvania USA or by an authorized representative.
2. Remove all plastic and/or paper shipping caps and restraints before operating.

3. Fill out and mail the yellow WARRANTY-REGISTRATION CARD (included with this manual) to ensure that the warranty will be validated and that you will be kept informed of any improvements or other items of interest.

D. Location

1. The Series 580 GC should be placed in a location that is secure, vibration-free, protected from abrupt temperature changes (maximum ambient temperature range is 15 °C to 40 °C), and drafts. Such changes may upset the temperature stability in the course of an analysis or preparation.
2. Enough adjacent tabletop space should be allowed for the installation of recorders, integrators, computers, etc. Allow sufficient space on all sides of the Series 580 GC for easy access.
3. Make sure there is adequate space for the installation of the carrier gas cylinder. Cylinders should be securely fastened to the wall or table.



READ "SECTION 2 - SAFETY" TO ENSURE PROPER HANDLING OF GAS CYLINDERS.

4. An electrical outlet (ac) should be near the location where the Series 580 GC is to be installed. If the outlet is not a 3-pin type, make sure that a good ground connection is available, since a good ground is necessary for proper operation. The ac outlet should be connected to a circuit that is not heavily loaded with other electrical equipment because input voltage to the instrument should be steady for optimum operating stability.

If the ac line voltage varies, consideration should be given to the installation of a stabilizing transformer at the ac outlet.

NOTE



Both recorder and the Series 580 GC should be connected to the same duplex service outlet to prevent ground loops.

E. Power Requirements

The Series 580 GC requires a 115 volt/60 Hz power source capable of providing up to 10 amps.

The Series 582 GC requires a 230 volt/50 Hz power source capable of providing up to 5 amps.

The ac power cord is terminated with a straight-blade 3-prong plug rated for 15 amp service that requires a matching receptacle.



MAKE SURE ALL SWITCHES ON FRONT AND BACK OF THE SERIES 580 GC ARE IN THE "OFF" POSITION BEFORE PLUGGING IN THE INSTRUMENT.

F. Recorder Connection

Supplied with your G.C. is a recorder cable. Both ends of the cable terminate in three spade terminals.

Cable color code is as follows: Red lead, positive (+); black lead, negative (-), silver (shielded) lead, ground.

1. Connect one end of the recorder cable to the terminals located at the rear of the G.C. (Figure 3-1). Connection should be made as follows:

Black to black
Red to red
Silver to green

2. Connect the other end of the recorder cable to the proper terminals on the recorder.

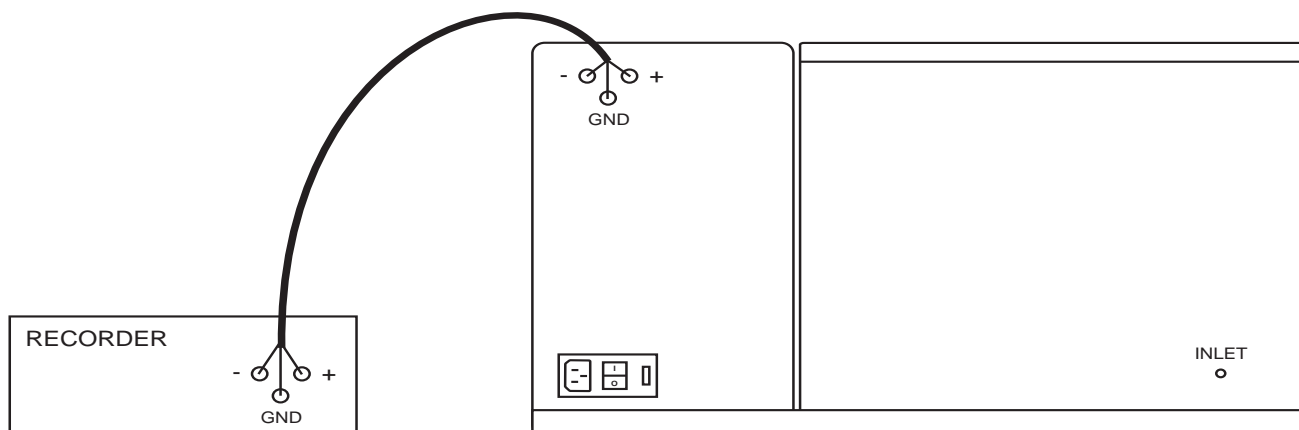

Figure 3-1
Recorder Cable Connection

G. Integrator Connection

The same cable referred to above can be used for connecting an integrator to the GC.

H. Chromatography Data handling Software

The Series 580 TCD GC may also be used with a chromatography data handling software for full data acquisition.

I. Gas Connections



READ "SECTION 2-SAFETY" BEFORE CONTINUING. O.S.H.A. REGULATION FOR THE HANDLING, STORAGE, AND USE OF COMPRESSED GAS CYLINDERS REFERS TO THE REQUIREMENTS OF THE COMPRESSED GAS ASSOCIATION.

1. A 1/8" o.d. stainless steel tube extends from the back of the G.C. (Figure 3-2). This is the CARRIER GAS INLET.

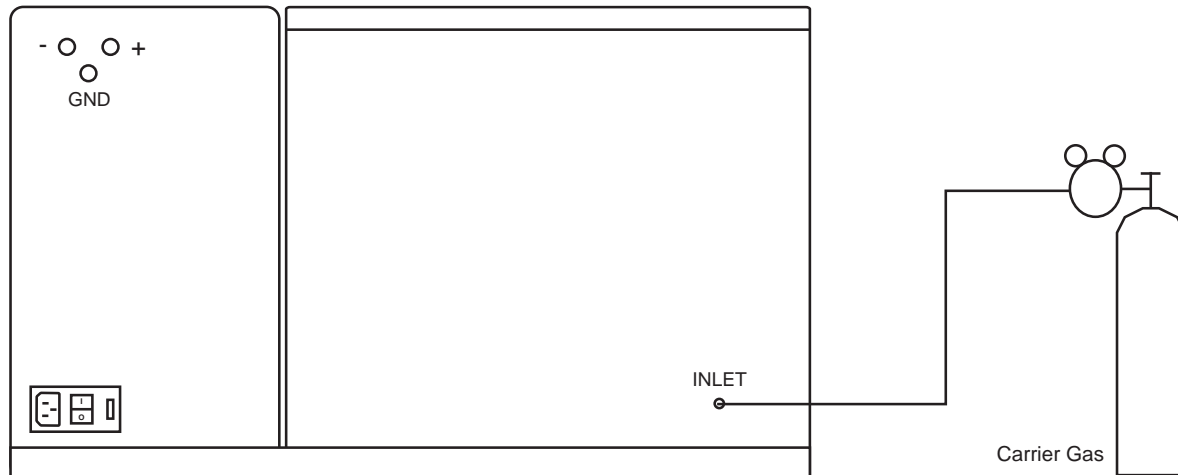

Figure 3-2
Carrier Gas Connection

2. Either using the GOW-MAC Installation Kit (Part No. 59-400) or fittings and copper tubing of your own, connect a 1/8" o.d. piece of clean copper tubing* from the gas outlet located on the regulator of the carrier gas cylinder to the CARRIER GAS INLET on the back of the GC (Swagelok® fittings are recommended).

NOTE



PLASTIC TUBING IS NOT RECOMMENDED, SINCE ALL PLASTICS ARE PERMEABLE TO AIR.

- * To prevent contamination of your GC by grease, oil, or chemical residue, the following procedure should be followed for purging additional stainless steel or copper tubing PRIOR to connecting it to the Series 580.
- a. Clean tubing by flushing with acetone, to remove any oil residue that may be present.
 - b. After washing, let tubing drain and dry.
3. All lines and tubing should be clean and free from moisture.

J. Leak Testing

All connections are thoroughly leak-tested prior to shipment from the factory.

Now that the carrier gas has been hooked up and is flowing, the following procedure for a leak check is recommended.

POWER IS TO REMAIN “OFF” THROUGHOUT THIS ENTIRE PROCEDURE!

1. Open the hinged COLUMN OVEN LID.
2. Check all column connections for tightness.
3. Check septum nuts, on front panel, for tightness (finger tight).
4. Check the carrier gas connections at the back of the Series 580 GC for tightness.
5. Check the fittings at the gas cylinder and copper tubing for tightness.
6. The COLUMN FLOW CONTROL VALVES are located on the front panel of the oven assembly (Figure 4-1, Section 4). These should be closed gently fully clockwise), then opened 1/2 turn counterclockwise (CCW).



THESE ARE PRECISION NEEDLE VALVES, NOT SHUT-OFF VALVES. CARE SHOULD BE EXERCISED IN MAKING ADJUSTMENTS.

7. Using Tygon® tubing, connect the two OUTLET PORTS together. (located on the left side of the GC)
8. Adjust the PRESSURE REGULATOR on the gas cylinder to a gauge pressure of 30 psig, then shut “OFF” the gas at the cylinder.
9. If the system is leak-free, the pressure gauge will remain at 30 psig. If the pressure falls off within 15 to 20 minutes, there is a leak in the system.
10. The easiest way to locate leaks in the system is through use of a GOW-MAC Gas Leak Detector, Model 21-070. If a leak detector is not available, the use of a leak testing solution (soap solution) and checking for bubbles may be used.

NOTE



STEPS 7,8, & 9 ABOVE MAY BE OMITTED IF A GOW-MAC LEAK DETECTOR IS AVAILABLE.

LEAK CHECKS SHOULD BE RUN PERIODICALLY AND ARE A MUST WHEN NEW COLUMNS OR CARRIER GAS FITTINGS ARE INSTALLED.

11. Once leaks have been located and stopped, return the instrument to operating condition: bleed all pressurized lines to atmospheric pressure; remove Tygon® tubing at OUTLET PORTS.

K. Gas Flow Adjustments

The GOW-MAC Digital Flowmeter for non-corrosive gases, part no. 180-567, is recommended to set the carrier gas flows. Attach flexible tubing to Outlet “A” on the GC and adjust the flow rate with the metering valve on the front of the instrument. Proper use of the Digital Flowmeter can be assured if used within the parameters set in its’ accompanying manual.

1. Turn on gas supply at cylinder.
2. Pressure settings depend upon the particular column(s) being used. Pressure MUST be at least 15 psig to activate the safety switch. Thirty (30) psig is adequate for most columns. Fifty (50) to one hundred (100) psig may be required for longer 1/8” packed columns (10’ or longer).
3. A bubble type flowmeter can also be used with a stopwatch. Gently squeeze the reservoir of the flowmeter until a stream of soap bubbles emerge. Allow several bubbles to rise and wet the sides of the glass meter. START the stopwatch when a bubble reaches the “0” mark on the meter. STOP the stopwatch when the bubble reaches the “10” mark on the meter. The elapsed time, in seconds, for the bubble to rise from “0” to “10” divided INTO 600 equals the flow rate in mL/min. Adjust SIDE “A” FLOW CONTROL VALVE for the desired rate (usually 60 mL/min.).

$$\frac{600}{\text{sec.}} = \text{flow rate (mL/min.)}$$

NOTE

BEFORE MEASUREMENT, ALLOW AT LEAST ONE MINUTE BETWEEN EACH ADJUSTMENT FOR THE RATE TO EQUILIBRATE.

4. Change the flowmeter to OUTLET PORT “B” and repeat Step 2, above, for the desired rate (usually 60 mL/min. for 1/4” columns or 30 mL/min. for 1/8” columns).
5. The flow rates have now been adjusted. Disconnect the flowmeter.

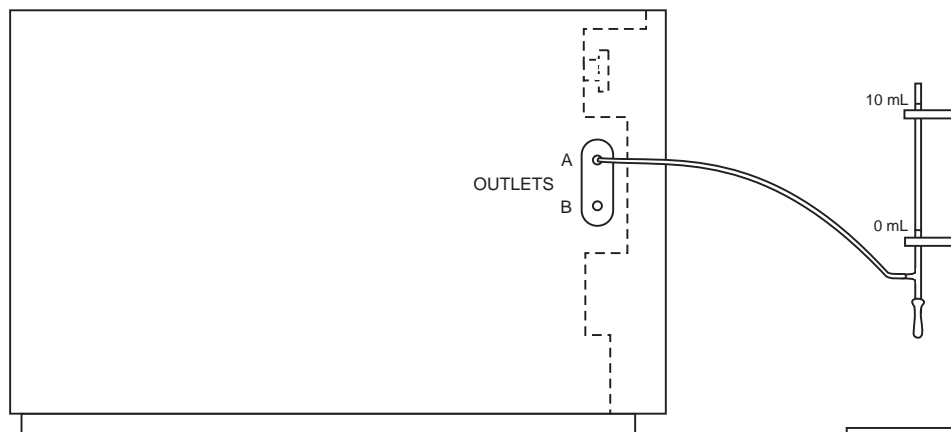

Figure 3-3
Gas Flow Adjustments Using a Bubble-type Flowmeter

L. Setting Flows For A Gas Sample Valve and Series/By-pass Column Switching Valve for Analysis of CH₄, CO₂, C₂H₆, H₂O, H₂, O₂/Air, N₂, CO

If this instrument is equipped with a Series/By-pass Valve (installed on the “A” side) use the following instructions for setting the flow rates.

1. Position S/B-P Valve in “Series” position.
2. Use carrier gas needle valve “A” to adjust flow to 30 mL/min. for 1/8” column, 60 mL/min. for 1/4” column.
3. Switch S/B-P Valve to “B-P” position.
4. Use needle valve marked “restrictor” (found in either the front or back of the Accessory Housing) to equal flow rate set in Series position, 30 mL/min. or 60 mL/min.

NOTE *Flows in series and by-pass position should be equal to each other as well as equal to “B” side setting.*

When setting flows on S/B-P Valve allow sufficient time for flows to stabilize. (2 - 5 minutes)

M. Installation Check List

1. Electrical

- _____ Correct voltage and frequency.
- _____ Interconnecting cables to additional instruments installed.
- _____ Power “OFF”

2. Pneumatic

- _____ Required gas supplies hooked up
- _____ Cylinders chained or strapped to wall or table. Regulators set for suggested delivery pressure (30 psig). Connecting lines and fittings leak checked.
- _____ Flow rates checked and adjusted.

Section 4

Operating Controls

This section of the manual will introduce you to the controls of your Series 580 GC.

A. Controls

With the exception of the MAIN POWER SWITCH (located on the rear panel), all of the operating controls are located on the right front panel of the GC. The operator should become familiar with these controls and their functions BEFORE operating the instrument. Refer to Figure 4

1. DIGITAL PANEL METER: Displays the value of the operating function chosen by the SELECTION BUTTONS.
2. SELECTOR BUTTONS:
 - a. COLUMN OVEN TEMPERATURE (°C): selects column temperature reading to appear on the DIGITAL PANEL METER.
 - b. DETECTOR TEMPERATURE (°C): selects detector temperature reading to appear on the DIGITAL PANEL METER.
 - c. INJECTION PORT TEMPERATURE (°C): selects injection port temperature reading to appear on the DIGITAL PANEL METER.
 - d. DETECTOR CURRENT: selects detector current reading to appear on the PANEL METER.
 - e. SET (IN)/ACTUAL (OUT): selects either actual or set-point parameters for any of the functions (a-d) above. This button should be left in the "ACTUAL" (OUT) position EXCEPT when settings are being changed.
3. COLUMN TEMPERATURE CONTROL: Selects the temperature of the column oven. Temperature is indicated on the DIGITAL PANEL METER when the COLUMN TEMP. BUTTON is pressed. (See "2e" above). Knob is "locking-type". Push locking ring "IN" to turn knob.
4. DETECTOR TEMPERATURE CONTROL: Selects the temperature of the detector oven. Temperature is indicated on the DIGITAL PANEL METER when the DET. TEMP. BUTTON is pressed. (See "2e" above). Knob is "locking-type". Push locking ring "IN" to turn knob.
5. INJECTION PORT TEMPERATURE CONTROL: Selects the temperature of the injection ports. Temperature is indicated on the DIGITAL PANEL METER when the INJ. PORT. TEMP. BUTTON is pressed. (See "2e" above). Knob is "locking-type". Push locking ring "IN" to turn knob.
6. POLARITY SWITCH: Selects the polarity (+/-) of the detector output signal. Allows use of each column without changing the wiring to reverse polarity on the recorder.

7. SIGNAL AMPLIFIER (Option 407): Amplifies the analog millivolt detector output signal by a factor of 10.
8. COLUMN HEATER & FAN SWITCH: Controls the operation of the column oven heater and fan. The heater will operate only when the switch is in the "Column Heater & Fan" position. This is the normal operating position. For rapid cooling of the oven, the heater may be turned off and the fan operated alone by placing the switch in the "FAN ONLY" position.
9. DETECTOR CURRENT CONTROL: Determines the sensitivity of the instrument. The higher the current, the more sensitive the instrument becomes. Charts 5-1 thru 5-4 illustrate the maximum current for each specific cell temperature. **THIS SHOULD NOT BE EXCEEDED!** However, for longer filament life and a stable baseline, lower filament temperatures are recommended. Reference recommended starting bridge settings (Section 5).

NOTE



DUAL CARRIER TCDs: Controls to set the TCD temperature and bridge current are as described above.

Special attention is required when setting the TCD temperature and bridge current on a dual carrier detector. Helium is normally one carrier gas while either nitrogen or argon is the other. To determine the operating limits of the TCD current and temperature, refer to Charts 5-4 and 5-5 in Section 5. Go to the particular chart for your filament type, then select the current and temperature to stay below and to the left of the curve for the appropriate carrier gas (N₂ or Ar).

10. ATTENUATOR: Twelve step, 1 to 1024 plus infinity, in multiples of 2. Attenuates the output of the bridge current. A setting of "1" represents maximum sensitivity.
11. ZERO CONTROL: Adjusts the detector output level for zeroing the baseline on the recorder. (Recorder should be zeroed first, with short input).
12. METERING VALVES: Adjusts the flow of detector the carrier gas to the detector.
13. INJECTION PORTS "A" & "B"
14. OVEN LID
15. EXIT PORTS "A" & "B"

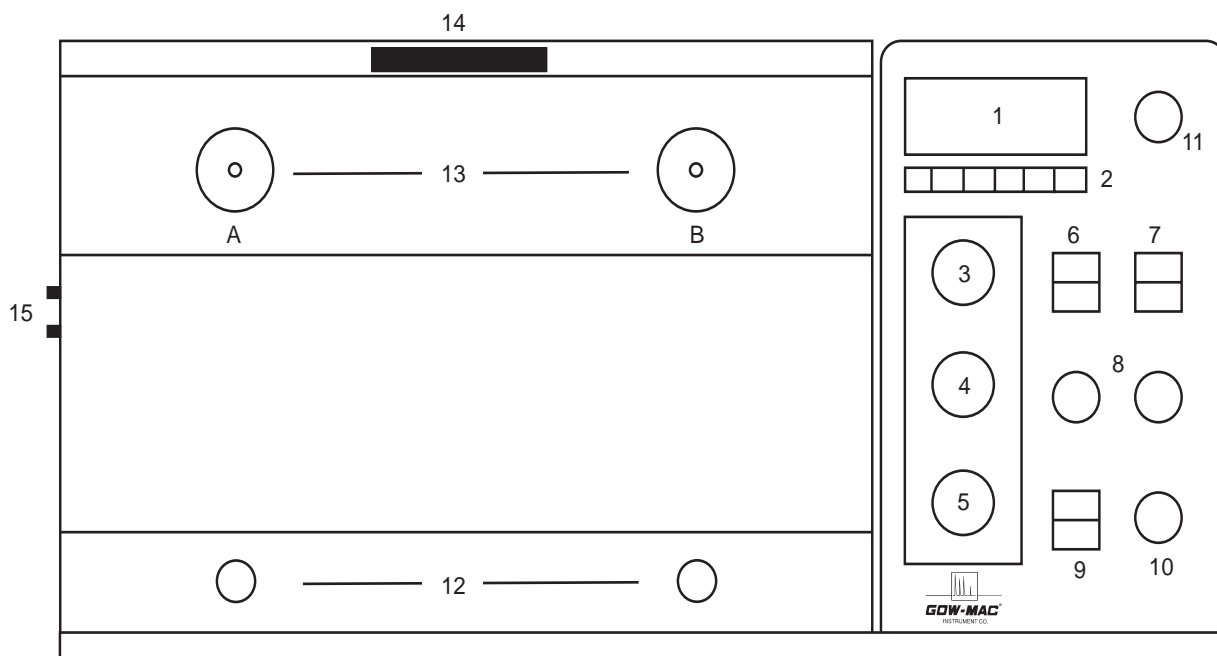

- | | |
|-------------------------------------|-------------------------------|
| 1. Digital Panel Display | 9. Column Heater & Fan Switch |
| 2. Selector Buttons | 10. Attenuator |
| 3. Column Temperature Control | 11. Detector Current Control |
| 4. Detector Temperature Control | 12. Metering Valves |
| 5. Injection Port Temp. Control | 13. Injection Ports "A" & "B" |
| 6. Polarity Switch | 14. Oven Lid |
| 7. Signal Amplifier, x10 (optional) | 15. Exit Ports "A" & "B" |
| 8. Zero Control | |

Figure 4-1
GC Controls (Typical)

B. Columns

The Series 580 GC is complete with four Swagelok® fittings for 1/8" o.d. columns. (Unless otherwise specified)

The oven is designed to accept twenty (20) feet of 1/4" column tubing. Correspondingly longer lengths of 1/8" tubing can be wound on a mandrel of 4" o.d. (a standard 1 lb. coffee can is about 4" in diameter). This technique **SHOULD NOT BE USED** with 1/4" tubing. Figure 4-2 illustrates column "B". An appropriate column or bypass must be installed in both "A" and "B" sides.

NOTE



**SPECIAL COLUMNS ARE NORMALLY NOT SUPPLIED
CONDITIONED READY FOR USE. NORMAL COLUMN
CONDITIONING PROCEDURES SHOULD BE OBSERVED BEFORE
ANALYSIS CAN BE PERFORMED. CARE SHOULD BE TAKEN
DURING CONDITIONING SO CONTAMINATION OF THE DETECTOR
DOES NOT OCCUR.**

Your Series 580 GC has been supplied with one (1) 4' x 1/8", stainless steel column packed with 5% OV-101 on Chromosorb P AW-DMDCS, 80/100 mesh.

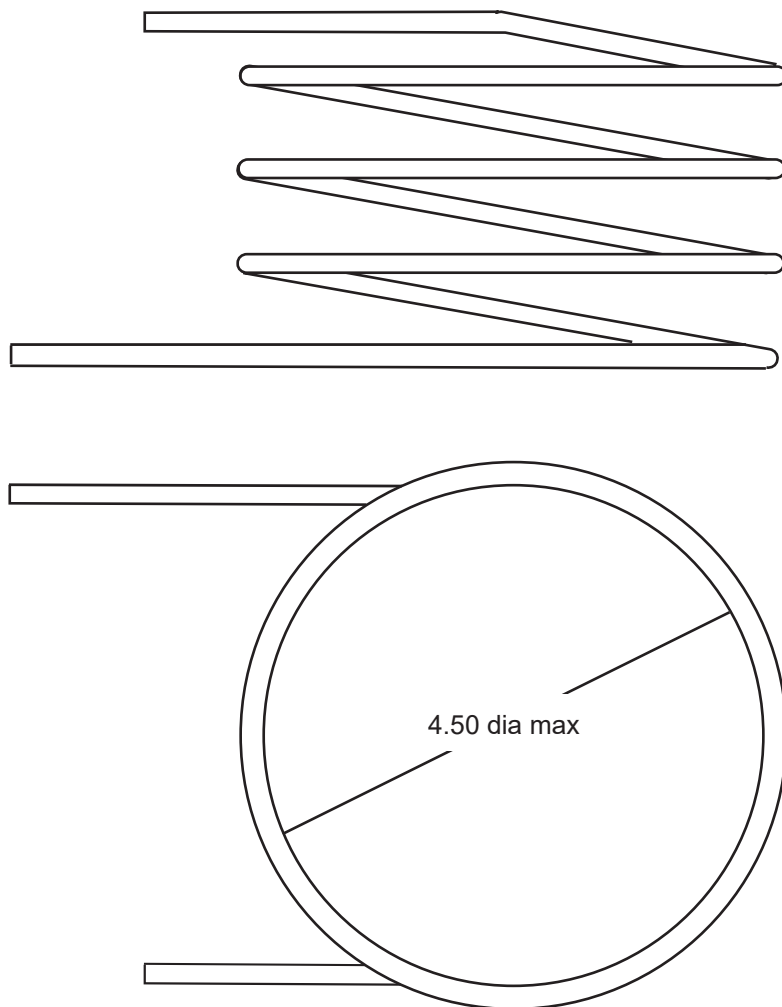

Figure 4-2
Column "B"

Section 5

Operation

A. General

The chromatographer should be familiar with the techniques of chromatography, the function of all controls, the operation of the recorder, and the characteristics of the columns used prior to running samples.

B. Operation

1. Gas Flow

- a. Make sure that ALL switches are in the "OFF" position.
- b. Set helium or other carrier gas pressure regulator to 40 psig.
- c. Adjust flow of carrier gas to: 30 mL/min. for 1/8" columns 60 mL/min. for 1/4" columns.
- d. Check for leaks as described in Section 3, Paragraph I.
- e. Disconnect flowmeter.
- f. Allow 5 minutes to purge the system before turning power "ON".

2. Temperature Controls

NOTE *TEMPERATURE CONTROL KNOBS are locking type. Push locking ring "IN" to turn knob.*

- a. Turn the DETECTOR CURRENT CONTROL fully counterclockwise (CCW). **THIS STEP IS EXTREMELY IMPORTANT!**
- b. Plug in the instrument to the appropriate ac outlet. Switch the instrument "ON".

Charts 5-1 thru 5-5 illustrate the maximum current for specific cell temperature and carrier gases helium, nitrogen, and argon for single and dual carrier detectors.

THESE SHOULD NOT BE EXCEEDED! However, for longer filament life and a more stable baseline, lower detector current is recommended. Reference recommended starting bridge settings (pg. 26).

EXAMPLE:

A setting of 200 on the DET. TEMP. CONTROL results in an operating temperature of 200 °C, thus maximum bridge current when using helium at this temperature is 240 mA. When maximum sensitivity is not required, the current should be reduced to 100 mA.

Single Carrier TCD

W, WX, W2, W2X, AuW, AuW2, Ni, Ni2 Filaments

Chart 5-1

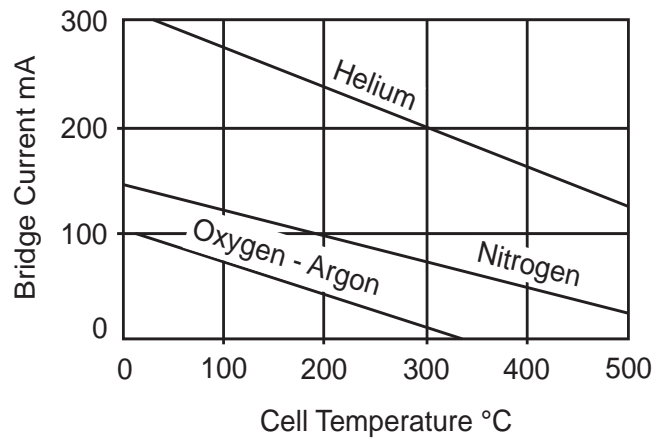

10-952 Cell with Wx7 Filaments

Chart 5-2

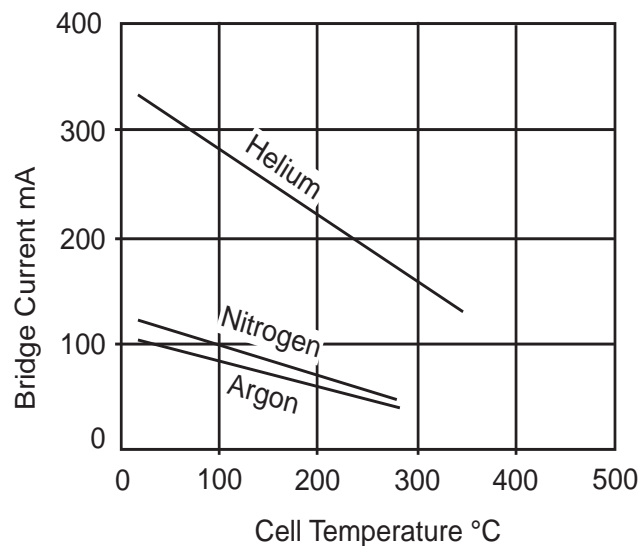
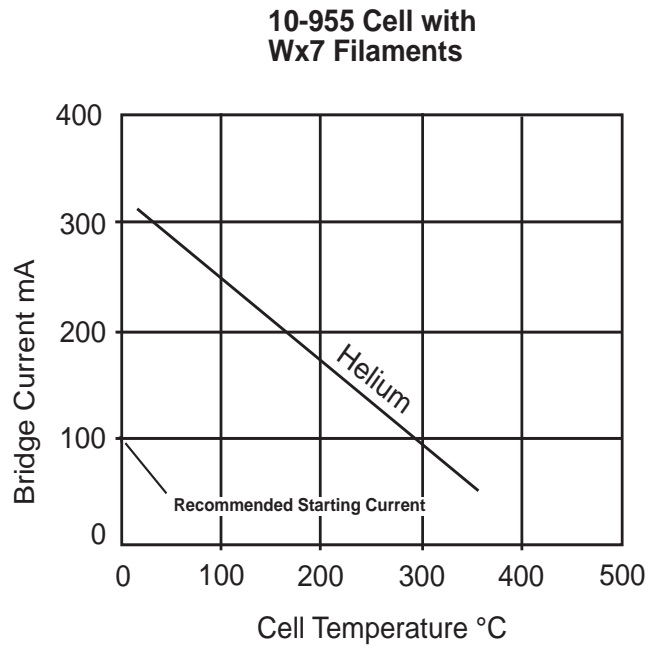
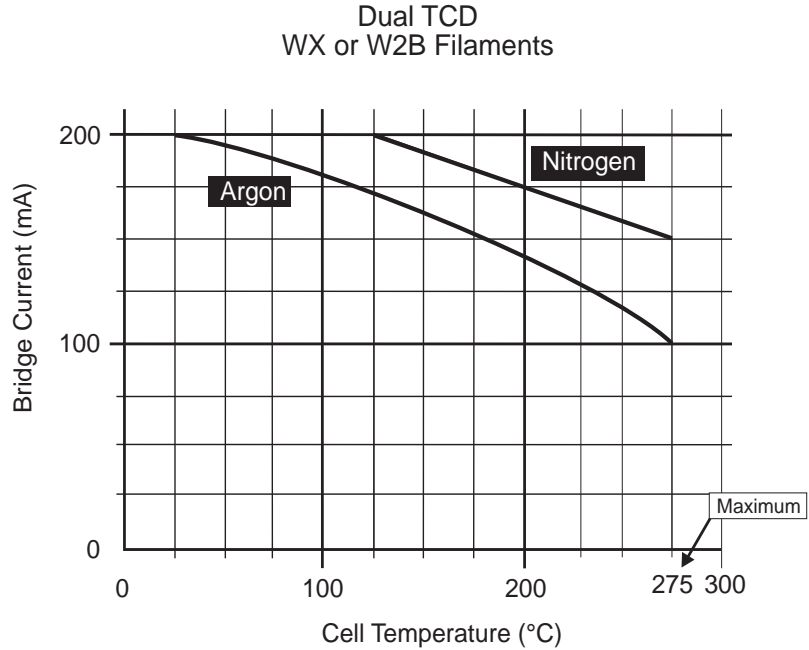

Chart 5-3



Dual Carrier TCD

Chart 5-4



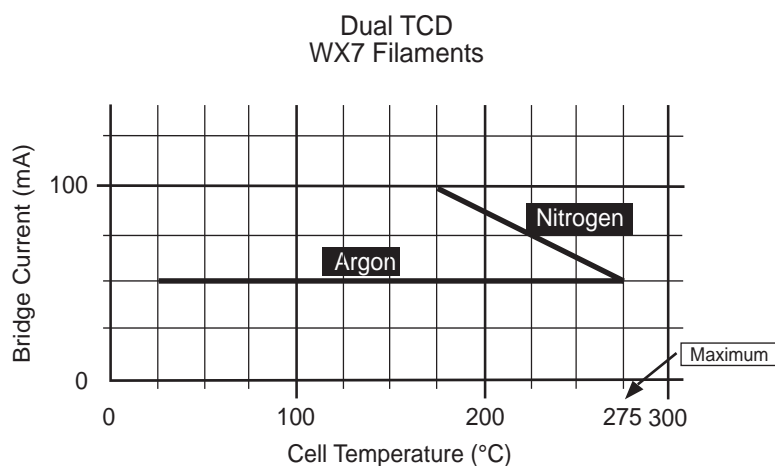

Chart 5-5

- c. Adjust the COLUMN TEMPERATURE CONTROL to desired setting.
- d. Adjust the DETECTOR TEMPERATURE CONTROL to desired setting.
- e. Adjust the INJECTION PORT TEMPERATURE CONTROL to desired setting.
- f. Turn the CURRENT CONTROL to 100 mA.

NOTE *If bridge current does not respond, check carrier gas pressure.*
Filament protector pressure switch (internal) must have at least 15 psig to operate. Set at 40 psig.

After approximately 45 - 60 minutes, the instrument should be up to temperature and ready for the injection of samples.

C. Strip Chart Recorder Zeroing

The Series 580 GC is suitable for use with almost any strip chart recorder of the potentiometric type (1 mV, 10 mV, or other. For best results and maximum sensitivity, the GOW-MAC Model 70-150A 1 mV Recorder is recommended. An adjustable chart drive is also recommended: 40, 20, 10, 4, 2, and 1 cm/min. and hour.

After the recorder is properly connected to the instrument, it may be turned "ON". At this time the electrical zero on recorder should be established. Proceed as follows:

1. Set the GC ATTENUATOR to the infinity position (∞).
2. Adjust RECORDER ZERO to move the pen to the desired baseline position (usually set at 5 or 10 small divisions on the chart paper). Where positive and negative peaks are expected, pen may be set mid-scale. If pen response is slow, the recorder may require adjustment (see recorder manual).
3. Set GC ATTENUATOR to "64". Adjust the GC ZERO CONTROL to reposition the pen to the same spot located in Step 2. The polarity should be set so that the drift due to warm-up is upscale. In this manner, the extent of drift and the leveling out of the baseline may be observed.

As the zero trace begins to level off, the GC ATTENUATOR may be reduced. The ATTENUATOR may be set at “1” when the zero trace is free from most drift and noise. Drift may continue as long as the oven or detector temperatures continue to change.

Refer to the recorder manual for correct chart speeds, warm-up times, etc.

D. Computing Integrator Zeroing

The Series 580 GC may be used with any computing integrator. An integrator makes full data acquisition more reliable and more accurate.

After the integrator is properly connected to the instrument, it may be turned “ON”. At this time the electrical or recorder zero should be established and reference should be made to the integrator operating manual.

E. The Series 580 GC may be used with data handling PC software.

After the software is properly installed and connected to the instrument, it may be turned “ON”. Reference should be made to the software operating manual.

F. Sampling Procedure

1. After a stable baseline is established, change the GC ATTENUATOR to a setting of “8”, then “4”, etc. until a straight-line trace is obtained at the selected temperatures.
2. INJECT the sample.
3. Observe the developing peaks. Set POLARITY to the setting (either + or -) which will give an upscale deflection for emerging peaks.

NOTE



If your Series 580 GC is equipped with a 10x signal amplifier and more sensitivity is required, switch the 10x signal amplifier to the “10x” position. Refer to Section 8.

G. Standby and Overnight Conditions

When the instrument is used intermittently during the day or is needed right away the next morning, it is recommended that the instrument be kept in “STANDBY” condition. This keeps the instrument ready to use without waiting for a long equilibration period. Proceed as follows:

1. Push the SET BUTTON and DETECTOR BUTTON “IN”.
2. Turn CURRENT CONTROL counterclockwise (CCW) until the DIGITAL PANEL METER displays “0”.
3. Reduce the carrier gas flow from 40 psig to 20 psig to save gas consumption (**FLOW RATE MUST NOT FALL BELOW 15 PSIG**).

H. Shutdown Procedure

The following sequence of steps should be followed in the given sequence to insure proper cool down of your GC and longer life of the detector filaments.

1. Push the SET and DETECTOR CURRENT BUTTONS "IN".
2. Turn the CURRENT CONTROL counterclockwise until the DIGITAL PANEL METER displays "0".
3. Repeat Steps 1 & 2 above for the COLUMN, DETECTOR, AND INJECTOR.
4. Let the instrument cool down for 30 minutes. For a quicker oven cool down, the column oven lid may be lifted and the COLUMN HEATER & FAN SWITCH placed in the "FAN ONLY" position.

IF THE INSTRUMENT IS NOT LEFT TO COOL PROPERLY, THE FILAMENTS MAY BURN OUT (OXIDIZE).

5. Elute all samples from the column BEFORE the columns cool down.
6. Turn ac power "OFF".
7. Turn helium or other carrier gas "OFF" when detector temperature is < 80 °C.



IT IS MOST IMPORTANT THAT ELECTRICAL POWER BE TURNED "OFF" BEFORE THE HELIUM IS TURNED "OFF". AS LONG AS THE CELL AND FILAMENTS ARE HOT, THE HELIUM SHOULD BE FLOWING. THE FLOW RATE CAN BE REDUCED TO CONSERVE HELIUM. CELL TEMPERATURE SHOULD BE BELOW 80 °C.



FOR CERTAIN SAMPLE COMPOSITIONS THAT INTERACT WITH ATMOSPHERICS (OXYGEN, MOISTURE, ETC), IT IS NECESSARY TO THOROUGHLY PURGE THE ENTIRE INSTRUMENT OF SAMPLE GAS BEFORE SHUTDOWN USING AN INERT GAS — INCLUDING THE SAMPLE INLET. THIS IS REQUIRED FOR SAMPLES WITH HIGH CONCENTRATIONS OF COMPOUNDS THAT FORM ACIDS (HF, HCl, HBr, ETC) OR REACT VIOLENTLY AND/OR CORROSIVELY WITH ATMOSPHERIC ELEMENTS.

I. Daily Setup Check List

It is good practice to check the following items at the beginning of each day or shift, and when starting up the instrument after a weekend shutdown.

1. Electrical

_____ Additional instrumentation is connected properly.

2. Pneumatic

_____ Gas cylinder pressure is sufficient.

_____ Cylinder pressure regulator set properly.

_____ Gas flow rates are adjusted properly.

_____ Appropriate columns are installed.

_____ Carrier gas flow pressure at 40 psig.

_____ Leak check made.

3. Front Panel

_____ All temperature settings are set BELOW the recommended circuitry maximum limits
(See Charts 5-1 thru 5-5)

_____ Recorder/Integrator/software zeroed.

Section 6

Valves

NOTE



If your instrument is not equipped with valves, go on to Section 7.

A. General

Many types of valve configurations are available with your Series 580 GC. The flow diagram of your valve arrangement appears on the following pages. For assistance in determining the proper valve for your application, contact GOW-MAC.

All valves must be treated with care. Foreign materials such as metal filings or abrasive particles can permanently damage the sliders of the valves. GOW-MAC installs stainless steel filter frits on the inlets of sampling valves to help protect against this type of damage.

The Series 580 TCD GC can be equipped with up to three (3) valves. They must be treated with care.



VALVES HAVE UPPER TEMPERATURE LIMITS WHICH, IF EXCEEDED, CAN PERMANENTLY DAMAGE SLIDERS.

***UPPER TEMPERATURE LIMIT FOR VALCO VALVES IN THIS GC:
175 °C.***

***UPPER TEMPERATURE LIMIT FOR ACTUATORS IN THIS GC:
150 °C.***

All valves may be fitted with pneumatic actuators which are available from GOW-MAC. Air pressure of 50 - 60 psig is required for proper operation.

B. Valves and Their Functions

Valves are used to accomplish two basic operations in GC. One is to inject a sample onto the head of the GC column and the other, to reroute or “switch” the flow of the carrier gas or sample stream.

Within the broad category of switching, there are many valve functions, such as back-flushing, detector switching or column selection. (See below).

Although most valves are categorized as either sampling or switching, some valves combine both functions and are termed “multifunction” valves.

C. Sampling Corrosive Materials

When dealing with harsh samples, such as chlorine gases and wet acid, valves made of Tantalum or Hastelloy C-276 are recommended.

Corrosion Resistance of Tantalum to Some Common Chemicals

<u>Excellent</u>	<u>Slow Attack</u>	<u>Not Recommended</u>
Sulfuric Acid	Strongly alkaline	Hydrofluoric acid
Hydrochloric acid	compounds	Fluorine gas
Nitric Acid		
All organic corrosive chemicals		

Corrosion Resistance of Hastelloy C-276 to Some Common Chemicals

<u>Excellent</u>	<u>Good</u>	<u>Not Recommended</u>
Acetic acid	Bromine Gas	Fluorine
Amines	Chlorine (wet)	Hydrofluoric acid
Ammonia	Hydrochloric acid	Hydrofluoride
Chlorine (dry)	Nitric acid	
Formic acid	Phosphoric acid	
Hydrogen chloride (dry)		
Hydrogen sulfide		
Phosgene		
Sulfur dioxide		

D. Gas Sampling Valve

The gas sample valve is used to introduce gas samples into the chromatograph on a reproducible basis. The sample may be taken from a static system or from a flowing stream. Valves are also used to back-flush column, column selection, sample selection and detector switching.

Since the most common use of the valve is for sample injection, only that application will be discussed here in general terms. The valve may be installed in place of, or in series with the injection port. The valve may be permanently connected to a sample source or the sample may be passed through by means of a pump or other sample container.

The size of the sample loop is fixed but can be changed easily. (see below)

The valve is first placed in the counter clockwise (CCW) position, that is, the valve handle is as far counter clockwise as it will go. At this time the sample is purged through the loop and the carrier gas merely passes through the valve to the column. When the valve handle is placed in the clockwise (CW) position, the carrier gas purges the sample from the loop and carries it through the column. The valve is then returned to the CCW position.

NOTE



The sample is released to atmosphere in either valve position.

Care must be exercised to allow sufficient time for the sample loop to be completely filled with the sample before injection. This is easily calculated from the carrier gas flow and size of the sample loop. The same holds true for time allowed for the sample to enter the column.

E. Sample Loops

Sampling valves are supplied with a 2 mL loop if not otherwise specified on the order. Other sample loops are available: 0.25 mL, 0.50 mL, 1.0 mL, 2.0 mL, 3.0 mL, 4.0 mL, 5.0 mL, 10.0 mL, and 20.0 mL.

PROCEDURE FOR REMOVING AND REPLACING LOOPS IN GAS SAMPLING VALVES

1. Remove the four (4) screws holding the valve housing lid in place. Remove valve housing lid.
2. Unscrew loop mounting fittings (2) and remove loop.
3. Insert new loop and tighten fittings.
4. Replace valve housing lid.

F. Pneumatic Actuated Valves

If pneumatic actuated gas valves are installed, you may override the auto feature by a switch on the front panel of the accessory housing. An air pressure of 30 - 50 psi is recommended to fully drive the valve.

Option 411 Interface PCB is used to activate auto valves from a TTL closure generated by an external source, i.e., computing integrator. Option 411 will time a maximum of three (3) valves.

Option 412 accepts up to two (2) valves in a separate, heated oven assembly located in the accessory housing.

G. Automatic Valve Operation (Interface PCB, Opt. 411)

The interface PCB enables the operator to control the pneumatic actuated valves that are installed in the *GC Accessory Housing* via an external controller.

This external controller must be able to supply an active high (+5 V) TTL signal to the corresponding terminals located on the rear of the *GC Accessory Housing*. This +5 V signal must be kept "ON" for the entire period of time the user wants to keep the valve actuated.

Connect the Interface Cable provided to the VALVE ACTUATORS Terminal Strip located on the back of the *GC Accessory Housing*. Moving top to bottom along the strip, attach the color coded wires in the following sequence:

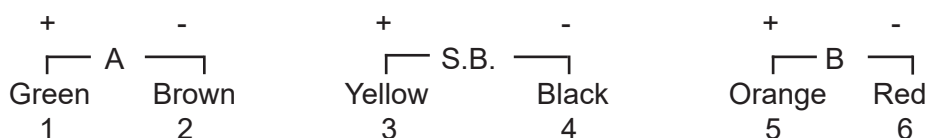

Refer to the External Control Option in the computing integrator operating manual for complete installation/operating instructions.

H. Injection Instructions for use with GSV and S/B-P Valves

If the instrument has GSV and S/B-P valves, it is equipped with a porous polymer (PP) (i.e., Porapak, Chromasorb, Hayesep) column and a molecular sieve 5A (MS5A) column. They are connected via the series/by-pass valve. When the S/B-P Valve is in the series position the columns are connected in series and the sample passes through both columns before entering the detector.

When the S/B-P Valve is in the By-Pass position, the sample by-passes the MS5A column and passes directly through the PP column to the detector.

An analysis which requires the separation of O₂, N₂, CH₄, CO, and CO₂ would normally require two separate injections to complete the separation.

The porous polymer column will not separate O₂, N₂, or CO from each other but will pass them right through the column. The Molecular Sieve 5A column will separate H₂, O₂, N₂, CH₄, and CO but will not allow CO₂ to pass through (CO₂ is adsorbed onto the MS5A).

A S/B-P Valve with PP and MS5A columns will allow the separation of H₂, O₂, N₂, CH₄, CO and CO₂ with one injection and one valve change

First an injection of certified standard of H₂, O₂, N₂, CH₄, CO and CO₂ is made with the S/B-P Valve in the B-P position. The porous polymer column will separate this standard into four components H₂, Air (O₂, N₂, or CO), CH₄ and CO. The separation of the Air and CH₄ may not be baseline on a 1/8" column but this is not important. The retention time from the point of injection to the valley between the CH₄ and CO₂ peak should be recorded.

After the above retention time is known, a sample containing H₂, O₂, N₂, CH₄, and CO can be injected into the instrument with the S/B-P Valve in the Series position. At the time of the above recorded retention time been reached the S/B-P Valve should be switched to the By-Pass position.

In this analysis the H₂, O₂, N₂, CH₄ and CO have been allowed to pass through the PP column onto the MS5A column. When the valve is switched from Series to By-pass these components are trapped on the MS5A, while the slower eluting component CO₂ comes off the PP column. After the last component comes off the PP column the S/B-P Valve is switched to the series position and the H₂, O₂, N₂, CH₄ and CO are eluted from the MS5A column.

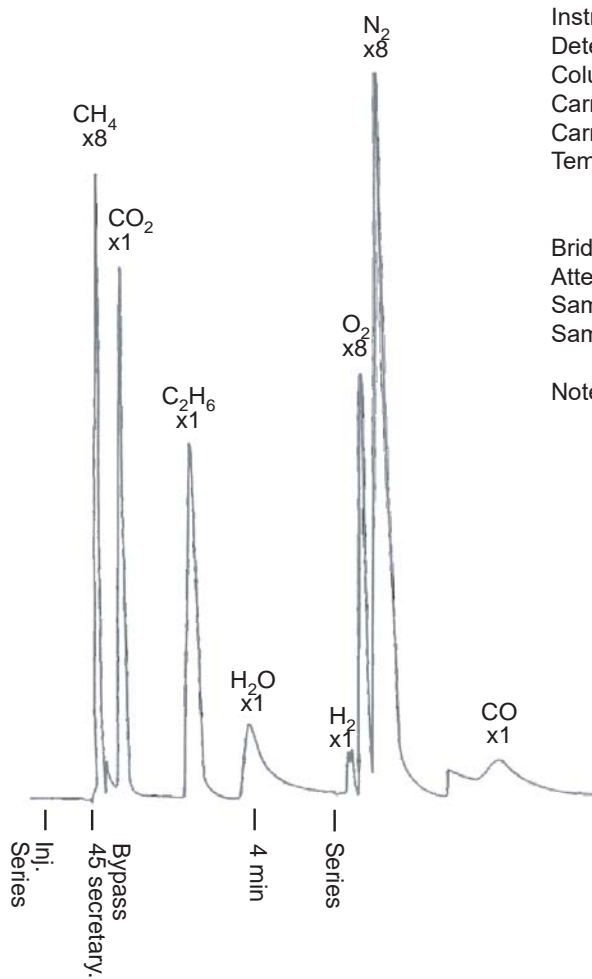

Instrument: Series 580
 Detector: TCD
 Column: See Note A
 Carrier Gas: Helium
 Carrier Flow: 40 cc/min.
 Temperature:
 Column 59 °C
 Detector 100 °C
 Bridge Current: 150 mA
 Attenuation: Noted
 Sample: Gas Mix
 Sample Size: 2 cc

Note A: Column #1 – 7' x 1/8" Porapak Q, 80/100 mesh
 Column #2 – 8' x 1/8" Molecular Sieve 5A, 80/100 mesh

Typical Chromatogram
 Analysis of Furnace Gases

Section 7

Maintenance

This section provides information concerning proper maintenance for the Series 580 TCD Isothermal GC. Schematics and drawings are provided for easy reference and assistance. If a problem arises which cannot be located, contact GOW-MAC for assistance: (610) 954-9000.

A. The Detector and Elements

1. Hotwires

Filaments available from GOW-MAC are made of gold-sheathed tungsten, tungsten, rhenium tungsten, nickel, and nickel alloy. Each has specific attributes which are exhibited under different requirements of analysis such as corrosion resistance, oxidation resistance, catalytic reactions and sensitivity.

CHEMICAL RESISTANCE BEHAVIOR OF VARIOUS GOW-MAC FILAMENTS

<u>Substance</u>	<u>Tungsten (W/WX)</u>	<u>Nickel (Ni/HR)</u>	<u>Gold Sheathed Tungsten (AuW)</u>
Oxygen	Good	Good	Very Good
Water	Good	Good	Good
Steam	Good below 700 °C	Good	Good
Ammonia/Amines	Good	Poor in presence of H ₂ O	Poor
CO/CO ₂	Good	Good	Good
Hydrogen	Good	Good	Good
Nitrogen	Good	Good	Fair
Fluorine	Poor (Fluoride forms at 20 °C)	Good	Poor
Chlorine	Fair	Good	Fair
Bromine	Fair	Good	Fair
Iodine	Fair	Good	Fair
Sulfur	Fair	Poor	Good
H ₂ S/SO ₂	Fair	Poor	Good
HCl	Fair	Good	Fair
Aqua Regia	Fair	Good	Poor
HF	Fair	Good	Fair
HF/HNO ₃	Poor	Good	Poor

2. Cleaning the Detector

Imperfectly vaporized liquid samples may be deposited on the filaments or cavity walls of the detector. Such deposits will affect the heat transfer properties of the detector and change the zero balance progressively until the zero will no longer be sufficient. Contamination of the detector may be removed in the following manner:

- a. Shut "OFF" carrier gas and electrical power to the GC.
- b. Remove columns from the column oven. Use 9/16 wrenches for 1/4" fittings and 7/16" wrenches for 1/8" fittings.
- c. Replace the columns with lengths of CLEAN copper tubing (Refer to Section 3, paragraph H, and Figure 7-1)
- d. Inject 100 mL of acetone through the septum and leave overnight.
- e. Purge the sampling system of the entire GC with helium at a flow rate of 20 mL/min. for one hour.
- f. With DETECTOR CURRENT at 100 mA, observe (1) completion of acetone purge, and (2) correction of detector contamination.



If your Series 580 GC has flow controllers (Option 402, part no. 180-173) installed instead of our standard metering valves, DO NOT clean your system with acetone as stated above.

The diaphragm in the flow controllers will dissolve requiring the entire flow controller to be replaced.

Call GOW-MAC for instructions on how to clean your detector.

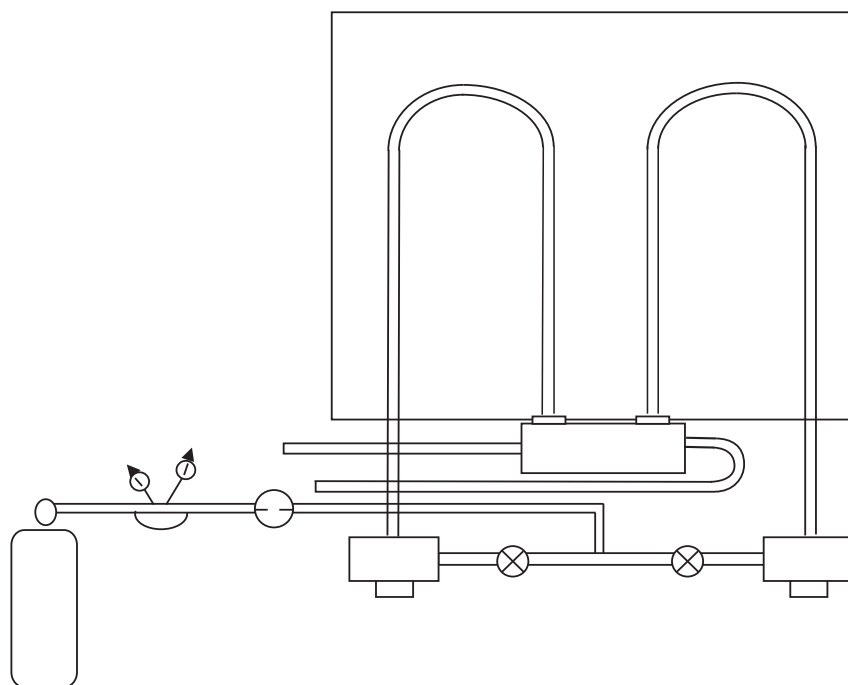

Figure 7-1
Column Placement

3. Detector Removal



BEFORE ATTEMPTING TO REMOVE THE DETECTOR OR FILAMENTS, ALL POWER TO THE INSTRUMENT MUST BE TURNED "OFF" BY REMOVING THE POWER CORD FROM THE OUTLET.



INSULATION CONTAINS FIBERGLASS. USE OF FACE MASK & GLOVES IS RECOMMENDED.

To remove the detector, use the drawings provided and proceed as follows:

- a. Remove the columns using 9/16" open-ended wrenches for 1/4" fittings or 7/16" wrenches for 1/8" fittings.
- b. Remove the two (2) screws located just above and below the OUTLET PORT .
- c. Remove the SEPTUM NUTS.
- d. Remove the six (6) screws from the FRONT OVEN PANEL.
- e. CAREFULLY remove insulation so as to expose the DETECTOR HOUSING.
- f. Remove the four (4) screws located directly above the lower column connections inside the column oven.

- g. Remove the two (2) screws located next to the lower column connections inside the column oven.
- h. Remove the four (4) screws located on the top and side of the CONTROL UNIT and remove the CONTROL UNIT COVER.
- i. Follow the detector cable and disconnect the detector cable from the Molex connector located in the CONTROL UNIT.

NOTE  ***Attach a string or wire to the Molex connector before pulling the detector leads out. This will assist in reinstallation of the detector.***

- j. CAREFULLY remove the DETECTOR HOUSING. In doing so, CAREFULLY draw the DETECTOR CABLE through the clearance hole from the CONTROL UNIT into the OVEN UNIT.
- k. Remove the DETECTOR HOUSING top by removing the four (4) screws.
- l. Remove the DETECTOR HOUSING front panel by removing the four (4) screws.
- m. Remove the DETECTOR HOUSING rear panel by removing the four (4) screws.
- n. CAREFULLY lift the DETECTOR out of cell housing.

4. Filament Replacement

To replace filaments, proceed as follows:

- a. Place cell in a vise.
- b. Using a 1/2" wrench, remove each of the four (4) bushings holding each of the four (4) filaments in place.
- c. Examine the detector for any accumulation of material and general cleanliness.
- d. Clean the detector if necessary before installing new filaments.
- e. Refer to the General Service Bulletin (following the WARRANTY page of this manual) for recommendations of installing new filaments.
- f. The new filaments should be installed in the detector, the bushings tightened, and a leak check made BEFORE replacing the detector housing. Refer to the GENERAL SERVICE BULLETIN for further assistance.

g. Leak Check Procedure

- ◆ Locate the column inlet ports on the DETECTOR HOUSING.
- ◆ Hook up CARRIER GAS to one INLET PORT.
- ◆ Connect the OUTLET PORTS together using clean plastic tubing. Then block the second INLET PORT to pressurize the detector (30 psig max.)
- ◆ With CARRIER GAS flowing, check for leaks around the bushings.
- ◆ If leaks occur, correct by tightening.
- ◆ Turn “OFF” the CARRIER GAS and disconnect from DETECTOR HOUSING.

6. Replace Detector

To replace the detector, go in reverse order of Step #3, a-n above, and leak test the system.

NOTE



Make sure that the TEMP. CONTROL SENSOR (1/8" x 1" ceramic) is properly installed in the small hole in the DETECTOR HOUSING bottom. This is only held in place by the insulation.

B. Columns

NOTE



When ordering new columns, please specify the instrument model number and serial number; whether the column is for side “A” or “B”; length, diameter, material, liquid phase, % loading, solid support, and mesh size.

1. Supplied Column

Care should be exercised to ensure that the column is not used below 30 °C or above the maximum temperature indicated on the column tag.

This column has been preconditioned.

2. Availability (Packed and coiled for installation)

GOW-MAC supplies columns for all it's GCs. Column materials include stainless steel or copper (1/4" or 1/8") or glass (6 mm o.d. x 2 mm o.d.). Columns may also be ordered empty.

GOW-MAC Instrument Co.
277 Brodhead Road
Bethlehem, PA 18017 USA
Tel: (610) 954-9000

3. Changing Columns

Figure 7-2 shows the injection port for low dead volume and on column injection. Either 1/4" or 1/8" o.d. columns can be used as shown. All 1/8" o.d. columns are furnished with 1/8" nuts and ferrules.

Care should be exercised when changing or removing columns. Damage to adjacent threads may occur if they are hit with a wrench or other object which may result in nuts becoming cross threaded.

Care should also be used when inserting the columns into the injection port assembly. Insert the column until it stops, making sure that it has reached the bevelled end of the injection port.

Then back off about 1/4" to allow carrier gas to sweep into the column. By using this technique, on-column injections can be attained. **CAREFULLY** tighten nuts with a 9/16" wrench (or 7/16" wrench for 1/8" fittings). **CHECK FOR LEAKS.**

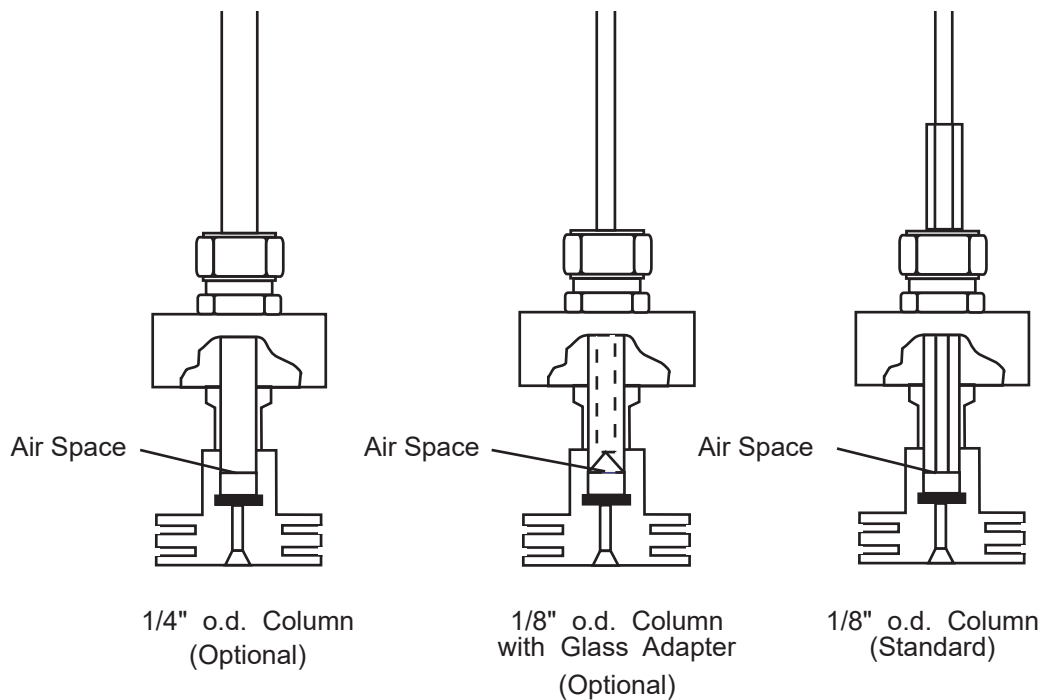

Figure 7-2
Injection Ports

C. Septums

The septums used in this instrument are standard 9 mm o.d. and may be obtained directly from GOW-MAC (Part No. 180-123). The INJECTION PORT NUT may be removed and the SEPTUM replaced. POWER TO THE GC MUST BE "OFF" and the instrument cool BEFORE removing the INJECTION PORT NUTS. The INJECTION PORT NUT acts as a heat sink, and as such, should be kept clean and polished.

NOTE: Be very careful when installing the column making sure not to have the column end too far in that it pushes out the front of the injection port. If this happens and the injection port nut is installed too tight, this will cause the carrier flow to be cut off. This could cause damage to the detector.



BURN HAZARD! INJECTION PORT NUTS MAY REACH VERY HIGH TEMPERATURES.

D. Temperature Control

The Series 580 GC can be operated at temperatures ranging from ambient to 400 °C. Operating temperature is maintained at the injection ports, the column oven, and the detector. Temperature controls on the injection ports, column oven, and detector are independent, solid state proportioning type. Proportioning cycle rate is approximately 2 1/2 sec. with a total band width of 5° C. Temperature readout and "SET" are on a 3 1/2 digit, digital meter. Selector buttons are used to read the desired temperatures.

A centrifugal blower fan circulates and distributes the heated air, thus eliminating temperature gradients. The blower also provides rapid cool-down when needed.

E. Column Oven

The column oven is heated by a 500 W tubular heater controlled by a proportional control. The solid state control incorporates a platinum RTD (Resistance Temperature Detector) and a 3-3/4 turn set potentiometer. Built into the circuitry is a fail-safe feature which disables the controller's triac output in the event of shorted or open sensor.

The "Temperature Fail Safe" feature has independent shut down at 400 °C for injection ports and detector. The column oven shuts down 30 °C above the column oven set point. The heating units return to safe condition when the temperatures decrease to safe levels. The controller is easily removed for service or replacement.

F. Detector Temperature Control

The detector is heated by two (2) 100 W heaters mounted in the DETECTOR HOUSING. The temperature control sensor is also located in the housing.

The detector temperature is controlled in the same manner as the column oven.

It is **IMPORTANT** to remember that the detector is heated by filaments as well as the heaters, and **CANNOT be operated at ambient temperature**. Even with the heaters turned "OFF", the detector will rise in temperature to about 70 °C due to the heat from the filaments.

G. Injector Temperature Control

The injection ports are heated by 60 W heaters mounted inside the injector block. The temperature control sensor is also located in the block.

The injection port temperature is controlled in the same manner as the column oven.

Section 8

Options & Accessories

The following are options and accessories that your Series 580 GC may (or may not) have been equipped with:

A. 10x Signal Amplifier (Option 407)

The 10x Signal Amplifier is a precision single, unified circuit designed for the acquisition of data in applications where there are less than desired operating conditions or where there is a need for high sensitivity.

The amplifier features a combination of high linearity, high common mode rejection, low off set voltage drift, and low noise gain applications.

B. Differential Flow Controllers (Option 402)

The Flow Controller controls low gas flows at constant mass flow rates with changes in downstream pressure. It maintains a preset differential pressure across a stratified (laminar) flow element. With a constant upstream pressure, flow is varied by changing the pressure drop across the stratified flow element. Once the differential pressure is set, it is maintained regardless of changes in the down stream pressure.

C. Capillary System

Capillary chromatography provides the utmost in GC performance. Advantages to using capillary techniques include high efficiencies about 4000 plates per meter versus about 500 plates per meter for packed columns- and shorter retention times with better resolution.

1. Columns

The SERIES 580 capillary GC is a direct, on-column injection system. Glass adapters with fittings are provided to install the capillary column (0.53 mm i.d. or larger).

When installing a new capillary column, the column should be placed into the detector as far as it will go. The other end of the column should be placed into the glass adapter approximately 3/4".

2. Injecting Samples

When injecting samples, make sure to insert the syringe needle about 2" through the injection port. This will ensure proper injection technique.

3. Capillary Detector

The capillary detector is a micro TCD optimized for capillary column gas chromatography on the basis of column efficiency, peak shape, detector signal to noise ratio and linearity. It is made of stainless steel and uses detector elements of a special alloy wire. Check the "Replacement Parts List" for replacement detector/ filaments.

D. The Preparative GC Collection System (Options 205, 206, or 208)

The system consists of four major components: (1) a temperature control unit, (2) a stainless steel column adapter with 6-32 npt female threads for connection to the heated exit port and found to accept a male $\frac{5}{8}$ joint, (3) a collection tube possessing a $\frac{5}{8}$ end, and (4) 100 μ L conical vials with threaded necks ground to a $\frac{5}{8}$.

The operation of the system is carried out in the following manner:

1. Temperature Control - The temperature of the heated exit ports is achieved with a separate control unit mounted on the outside left of the instrument. Included in the temperature control unit is:
 - Dial to set the temperature
 - Meter for temperature readout
 - On/off indicator light

NOTE



**METER IS NOT A DIRECT TEMPERATURE READOUT
AND TEMPERATURE SHOULD BE DETERMINED BY
EXPERIMENTATION.**

2. The column adapter is attached to the column exit port of the GC instrument which is located directly after the hotwire detector (front, left). The heated exit port is threaded to match the 6-32 adapter.

MOST IMPORTANT! The threads of the exit port must extend sufficiently along the exit port section of the column so that the end of the column will extend well into the ground standard taper part of the adapter when it is attached to the exit port.

This arrangement will allow the end of the exit port to butt snugly against the collection tube when fully assembled. IT IS ABSOLUTELY ESSENTIAL THAT THIS CONTACT IS MADE.

3. When the recorder indicates that the fraction to be collected is approaching the end of the columns, the collecting tube (previously cleaned and dried) is seated into the stainless steel adapter.
4. The assembled adapter and collection tube are then translated along the exit port tubing by rotating the adapter until the exit port butts against the end of the collection tube. If too much pressure is applied by the rotation of the adapter, the collection tube will unseat. It is important to practice rotating the collection tube GENTLY to obtain just enough pressure to make a good seal, but not too much to unseat the joint.

- The preparative GC fraction is now collected as it passes through the exit port. Efficient collection is facilitated (diminished aerosol formation) by the large heat sink afforded by the mass of the stainless steel adapter. Once the recorder indicates that the fraction is off the column, the collection tube is detached from the column adapter.
- The collection tube is then connected to a tares 100 μL conical vial via the $\frac{3}{5}$ joint and placed in a centrifuge tube (cotton padding around the collection tube and bottom of the vial is recommended). Refer to the Figure 8-1. The system is then centrifuged. The collected GC fraction is efficiently packed into the conical vial by this procedure. The vial is then detached from the collection tube, capped and weighed.

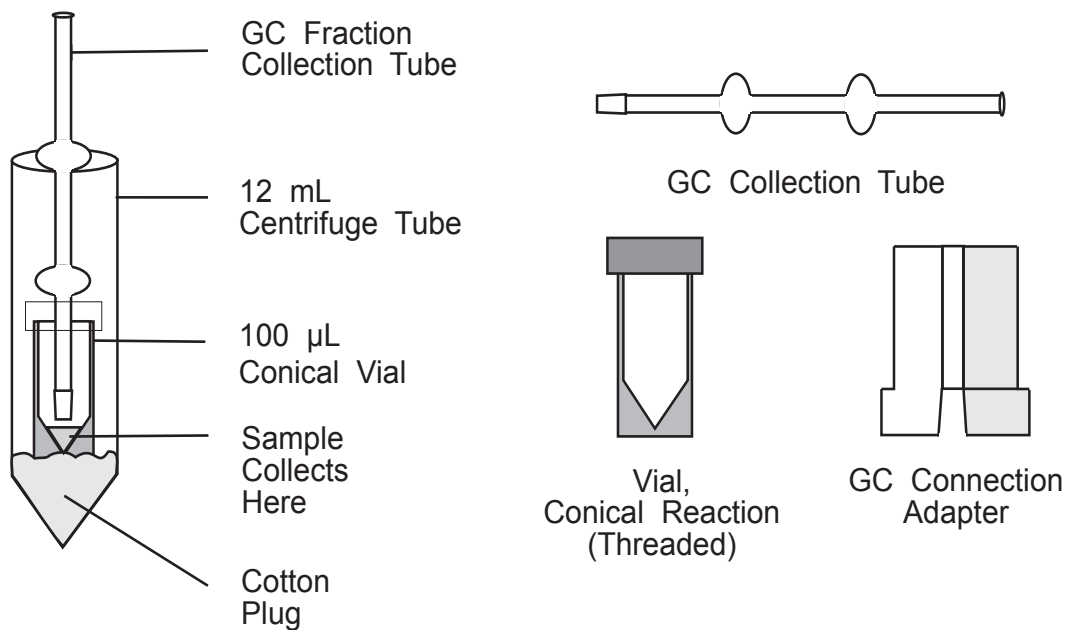

Figure 8-1
Microscale Prep Kit

E. Dual Carrier TCD

With a TCD helium is usually used as the carrier gas. In order to achieve high sensitivity the samples should have a different thermal conductivity than the carrier gas. Most of the components we want to analyze have vastly different thermal conductivities from helium so we get good sensitivities for the compounds we want to analyze and helium is readily available in the USA. Hydrogen can be used with good chromatographic results, however, hydrogen is **flammable** and not commonly used. Argon or nitrogen is used as the carrier gas in the second chamber of the dual TCD. These carriers allow for the detection and quantitation of hydrogen and/or helium, both of which are transparent when using a helium carrier.

Filaments are either WX, W2, or WX7. Refer to the opening page of this manual to verify which set of filaments are in your GC.



Section 9

Troubleshooting



CHROMATOGRAPHIC INTERPRETATIONS*



<u>Symptom</u>	<u>Cause</u>	<u>Remedy</u>
No peaks	Power supply malfunction.	Check fuses.
	Incorrect mode selected on detector controller module.	Depress correct select button.
	No carrier gas flow.	Turn on carrier gas; replace carrier gas cylinder if empty; Check for obstructed carrier gas lines.
	Injector septum leaking.	Replace septum.
	Column connections leaking.	Tighten connections.
	Carrier gas connected to wrong injector.	Provide correct carrier gas connection to injector.
	Recorder not properly connected; recorder defective.	Check recorder connections (see recorder manual).
	Syringe leaking or plugged.	Replace syringe.
	Insufficient carrier gas pressure (15 psi min.).	Check carrier gas pressure.
	Attenuation set too high.	Lower attenuation.

*Taken from "Basic Gas Chromatography" by McNair and E. J. Bonelli (available from GOW-MAC, Part No. 145-101).

<u>Symptom</u>	<u>Cause</u>	<u>Remedy</u>
Poor sensitivity with normal retention times.	Insufficient sample size.	Increase sample size
	Decomposed sample.	Prepare fresh sample.
	Poor injection technique.	Review injection techniques.
	Syringe leaking or plugged.	Replace syringe.
	Carrier gas leaking at injector septum, column fittings, etc.	Locate and correct leak.
	Incorrect column installation causing injection to miss column or excessive dead volume on detector end.	Replace column or reinstall column using new ferrules.
Poor sensitivity with increased retention time.	Carrier gas flow rate too low.	Adjust carrier gas rate; Check for depleted carrier gas supply obstructed carrier gas lines.
	Carrier gas leaking at injector septum, column fittings, etc.	Locate and correct leak.
	Column temperature too low.	Increase column temperature.
Negative peaks	Polarity switch in wrong position.	Select correct polarity for location of analytical column.
	Sample injected into wrong column.	Inject sample into correct column.
Irregular baseline drift when operating isothermally.	Poor instrument location.	Move instrument to location where it is not subject to drafts and/or ambient temperature changes.
	Instrument not properly grounded.	Make sure instrument and recorder are connected to good earth ground.
	Recorder defective.	Set GC Attenuator to 00. If drift continues, recorder is defective. See recorder manual.

<u>Symptom</u>	<u>Cause</u>	<u>Remedy</u>
	Carrier gas leaking at injector septum, column fittings, etc.	Locate and correct leak.
	Column packing bleeding.	Condition column; Operate column at a lower temperature; Replace column or packing. Some packing materials cannot be operated at elevated temperatures without difficulty. Drifting may occur even on well conditioned columns in which carrier gas flow rates have been carefully optimized.
	Poor carrier gas regulation.	Check carrier gas supply pressure; Check carrier gas regulator and flow controller to ensure proper operation.
	Poor grade of carrier gas or contaminated cylinder.	Replace cylinder. Carrier gas should be "zero grade" or better. Consult local gas supplier.
Sinusoidal a baseline drift.	Detector-oven temp. controller or sensor defective or improperly installed.	Check temperature sensing probe for resistance (approx. 100 Ω at room temp.) and proper installation.
	Column oven temperature controller or sensor defective or improperly installed.	Same as above.
	Poor instrument location.	Move instrument to a location where it is not subject to drafts and/or ambient temperature changes.
	Carrier gas flow regulator defective.	Replace carrier gas flow regulator.
	Carrier gas supply pressure too low to allow regulator to control properly.	Replace carrier gas cylinder.

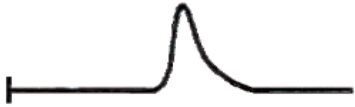
<u>Symptom</u>	<u>Cause</u>	<u>Remedy</u>
Constant baseline drift in one direction. 	Detector temperature increasing (decreasing). Leaks causing filament oxidation. Column bleed.	Allow sufficient time for detector to restabilize after changing its temperature. Check for leaks. Replace column(s).
Irregular baseline shifting. 	Column not properly conditioned. Excessive column bleeding from well conditioned column.	Condition column. Use different column. Some packing materials cannot be operated at elevated temperatures without difficulty. This symptom may occur even on well conditioned columns in which carrier gas flow rates have been carefully optimized.
	Column contaminated or excessive column bleed.	Recondition column.
	Contaminated injector.	Clean injector and replace septum.
	Contaminated detector.	Clean detector.
	Defective recorder.	Set GC Attenuator to infinity (∞). If noise continues, check recorder. See recorder manual.
	Recorder slidewire dirty.	Clean recorder slidewire.
	Carrier gas flow rate too high.	Reduce carrier gas flow rate.
	Carrier gas leaking.	Locate and correct leak.
	Bad ground connection.	Make sure all instruments are connected to good earth ground.
	Electronic circuitry dirty.	Consult GOW-MAC Engineering.

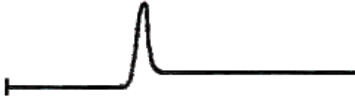
<u>Symptom</u>	<u>Cause</u>	<u>Remedy</u>
	Excessive electrical noise from power source.	Use line filter of sufficient power or connect to "clean source".
Tailing peaks 	Injector temperature too high or too low. Septum contaminated. Column oven temperature too low. Incorrect column for application. Interaction between sample material and column mobile phase or solid support.	Readjust injector temperature. Replace septum. Increase column oven temperature. Use different column.
Baseline stepping. Baseline does not return to zero, attenuation is incorrect, peaks are flattopped. 	Instrument and/or recorder not properly grounded.	Make sure instrument and recorder are connected to good earth ground.
	Recorder gain and/or control improperly adjusted.	Adjust recorder gain and/or damping control. Refer to recorder manual.
Baseline cannot be properly set. 	Adjustable recorder zero not properly set. Recorder improperly connected. Recorder defective. Excessive background from column bleed.	Set detector controller ATTENUATOR switch to ∞ and adjust recorder zero. Check recorder connections. Remove any connections between recorder inputs and ground or shield. See recorder manual. Condition column; use different column.

Symptom

Sharp spiking at irregular intervals.
locate



Cause

Quick atmospheric pressure changes and closing doors, blowers, etc.

Loose column fittings.

Electronic circuitry defective.

Excessive electrical noise from power source.

Remedy

Relocate instrument to minimize problem. Do not under heater or air conditioner blowers.

Tighten column connections.

Consult GOW-MAC Engineering.

Use line filter of sufficient power rating or connect to "clean source".

Short spikes or peaks at regular intervals.

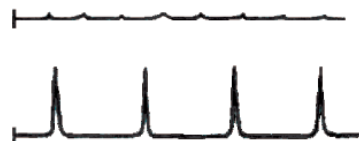

Condensation in flow lines causing carrier gas to bubble through.

Heat lines to remove condensation while purging with dry gas.

Leading peaks



Column overloaded. Sample size too large for column diameter and length.

Decrease sample size.

Sample condensed in system.

Check that injector and detector settings are correct.



Column oven temperature too high.

Reduce column oven temperature.

Column too short.

Use correct column.



Mobile phase has baked off of column support material.

Replace or repack column.

Incorrect column for application.

Consult GOW-MAC for column advise.

Carrier gas flow rate too high.

Reduce carrier gas flow rate.

Poor injection technique.

Review sample injection techniques.

Symptom

Cause

Remedy

Round-topped peaks.



Operating beyond linear dynamic range of detector.

Reduce sample size.

Recorder gain too low.

Adjust recorder gain. See recorder manual.

Square-topped peaks.



Detector controller output exceeds recorder input range.

Normal for solvent peak. Reduce detector sensitivity, if desired.

Recorder slidewire defective or mechanism binding.

Check recorder operation. See recorder manual.

Wrong attenuator setting.

Check attenuation.

Extra peaks.



Heavy residual material eluting from previous sample injection. (chromatogram I).

Allow sufficient time for previous sample injection to elute.

Chrom I

Air peak (chromatogram II).

Normal when making syringe injections.



Desorption from column packing when solvent is injected (chromatogram II).

Make several solvent injections and recondition column.

Chrom II

Sample decomposition (chromatogram II).

Reduce injector temperature. Use different column if packing material is causing or catalyzing decomposition.



Contaminated sample

Ensure proper preparation of sample prior to injection.

Sample interaction with mobile phase or column packing (chromatograms I, II).

Use different column. Consult GOW-MAC for column advise.

Contamination from glassware, syringes, etc. (chromatograms I, II).

Make sure all glassware, syringes, etc., are clean.

Section 10

Replacement Parts

When ordering replacement parts for your Series 580 GC, please specify the serial number of the instrument.

	<u>Description</u>	<u>Part No.</u>
Heaters (115 V)	Column oven heater 500 W	124-183
	Detector oven heater 100 W	124-185
	Injection port heater 60 W	124-152
Heaters (230 V)	Column oven heater 500 W	124-184
	Detector oven heater 100 W	124-186
	Injection port heater 60 W	124-153
Electronic Modules (115 V)	Current supply	123-191
	Temperature Controller PCB	123-177
	Display/Switch Interface PCB (before S/N C38001)	123-185
	Display/Switch Interface PCB (after S/N C38002)	123-194
Electronic Modules (230 V)	Current supply	123-191-240
	Temperature Controller PCB	123-177-240
	Display/Switch Interface PCB (before S/N C38001)	123-185
	Display/Switch Interface PCB (after S/N C38002)	123-194
Mechanical Assemblies	Injection port assembly	069-86-1
Electronic Parts and Controls	Zero potentiometer, 20K	111-178
	Receptacle, power switch w/ line filter (115/230 V)	129-152-10A
	Fuse, 10 A (115 V)	121-162
	Fuse, 5 A (230 V)	121-177
	Attenuator board assembly/switch	123-175
	Power cord (115 V & 230 V)	127-378
	Blower Motor Kit	069-91
	Neon pilot light	127-329
	Knob	127-354
	Switch, fan	120-169
	Switch, polarity	120-168
	x10 signal amplifier (option)	123-159-1(2)
	Digital Meter (S/N D55410 & higher)	128-182
Miscellaneous	Injection port nut	176-125
	Metering valves	180-789
	Septums, 9 mm silicon	180-123S
	Probe, platinum	124-175
	Feet, rubber, self-adhesive	141-947
	Column Adapters (1 pair per column) 1/4" to 1/8"	180-254
	Recorder cable, 6'	141-354

Series 580 Filament Replacement Chart

<u>Part No.</u>	<u>Description</u>	
13-580-QD	WX filaments	NOTE: Filaments are supplied in QUADS. A QUAD consists of 4 matched elements mounted in an aluminum block for safe shipping. Each QUAD includes 4 new tube nuts.
13-581-QD	AuW filaments	
13-582-QD	Ni filaments	
13-583-QD	WX7 filaments	
13-585-QD	W2 filaments	
13-586-QD	W2X filaments	
13-587-QD	Ni2 filaments	
13-584-18	8k Thermistors	NOTE: Sold in pairs

Series 580 Detector Replacement Chart

Detector Option <u>Number</u>	Detector <u>Part No.</u>	<u>Description</u>	<u>Filaments</u>
200	10-580-00-2	TC cell, s.s. standard w/ 1/8" fittings (10-077)	WX
201	10-580-01-1	TC cell, s.s. standard w/ 1/8" fittings (10-077)	AuW
202	10-580-02-1	TC cell, s.s. standard w/ 1/8" fittings (10-077)	Ni
203	10-580-03-1	TC cell, s.s. standard w/ 1/8" fittings (10-077)	WX7
207	10-580-07-1	TC cell, s.s. standard w/ 1/8" fittings (10-077)	W2X
224	10-580-24-2	TC cell, s.s. standard w/ 1/8" fittings (10-077)	Ni2
204	10-580-04-1	TC cell, s.s. capillary w/ 1/8" fittings (10-955)	*WX7
205	10-580-05-2	TC cell, s.s. prep w/ 1/8" fittings (10-077)	WX
206	10-580-06-1	TC cell, s.s. prep w/ 1/8" fittings (10-077)	AuW
207	10-580-08-1	TC cell, s.s. prep w/ 1/8" fittings (10-077)	Ni
209	10-580-09-1	TC cell, s.s. nanokatharometer w/ 1/8" fittings (10-952)	*WX
210	10-580-10-1	TC cell, s.s. nanokatharometer w/ 1/8" fittings (10-952)	*AuW
211	10-580-11-1	TC cell, s.s. nanokatharometer w/ 1/8" fittings (10-952)	*Ni
212	10-580-12-1	TC cell, s.s. nanokatharometer w/ 1/8" fittings (10-952)	*WX7
213	10-580-13-2	TC cell, s.s. thermistor (10-133 type)	8k
214	10-580-14-1	TC Cell, s.s. GADE	W2
218	10-580-18-4	TC cell, wide bore capillary w/ 1/8" & 1/16" fittings (10-952)	*WX
219	10-580-19-1	TC cell, wide bore capillary w/ 1/8" & 1/16" fittings (10-952)	*AuW
220	10-580-20-1	TC cell, wide bore capillary w/ 1/8" & 1/16" fittings (10-952)	*Ni
221	10-580-21-1	TC cell, wide bore capillary w/ 1/8" & 1/16" fittings (10-952)	*WX7
225	10-580-25-1	TC cell, s.s. dual carrier w/ 1/8" fittings (10-801)	*W2B
227	10-580-27-1	TC cell, s.s. dual carrier w/ 1/8" fittings (10-801)	*WXB

***NOTE:** THESE FILAMENTS ARE NOT FIELD REPLACEABLE. DETECTOR MUST BE SENT TO GOW-MAC FOR REPAIR.

Section 11

Drawings & Schematics

Flow Diagram

Wiring Schematic

Health and Safety Declaration for the Return of GOW-MAC Instrument Co. Equipment

In order to protect our employees from exposure to various hazards, the following statements and/or questions **MUST** be answered by you. Fill out this document in its entirety and either fax or e-mail it to GOW-MAC Instrument Co., Attn: Repair Dept, **BEFORE** returning the product.

The instrument/device/part being returned **will not** be accepted into GOW-MAC's facility until we receive this completed document. Once the product has been approved for return by our Chemical Safety Officer, an acknowledgement will be promptly issued to you with notification of your **Return Materials Authorization (RMA) number** and the procedure to follow for returning the product. *All applicable regulations should be followed when returning instrumentation, devices, and or parts.*

Customer to Record the Following:

Model # / Part #: _____
 Serial #: _____
 Service Technician spoken to: _____
 Today's Date: _____

If this form is not approved by our chemical safety officer, the instrument/device/part WILL NOT be permitted into our facility for servicing!

A) Briefly list the application(s) for which the instrument/device/part was used, as well as any and all chemicals, gases, and/or materials analyzed and their concentrations. (**MUST be filled in**): _____

B) Is there the possibility of internal or external contamination on or in this instrument/device/part?
 Yes – see below No – proceed to C.

Please check the appropriate box.

- Chemicals or Substances That Are Hazardous to Health
- Blood, Body Fluids, (e.g. Urine, Secretions), Pathological Specimens
- Regulated Medical Wastes
- Infectious Substances or other Bio-Agents (e.g. Protein, Enzymes, Antibodies)
- Radioactive Isotopes used in the area. Detail type (ECD, Isotopic Labels, etc) and Activity in Micro Curies
- Biodegradable Material That Could Become Hazardous
- Other Hazards _____

If any of the above boxes are checked the following statements and/or questions must be answered.

1. Specifically describe where (on or in) the instrument/device/part there could be any residual contamination (for example: blood spill on the surface). _____
2. Provide details of these hazards. Include names, Material Safety Data Sheets (MSDS), and concentration of contaminants, where possible. _____
3. Describe the method of decontamination used. Attach Procedure. _____

C) I declare that the above information is true and complete to the best of my knowledge. I acknowledge that any inconsistencies between the condition of the instrument and the statements made on this form will delay the repair process.

Authorized signature _____ Date: _____
 Name (Printed) _____ Phone number: _____
 Company name: _____ Fax number: _____
 Shipping address: _____
 City: _____ State/Country: _____ Zip : _____
 E-mail address: _____

BEFORE item can be shipped, fax completed form to: (610) 954-0599 or e-mail it to: repairs@gow-mac.com

For GOW-MAC Use Only:

- Passed Safety Inspection. **OK** to proceed to Repair Dept.
- Failed Safety Inspection. **DO NOT** proceed to Repair Dept.

Signed: _____ Date ____/____/____
 Chem. Safety Off. Comments: () None
 RMA No: _____ () On Back >>>>



